

COVERS AND POOL EQUIPMENT

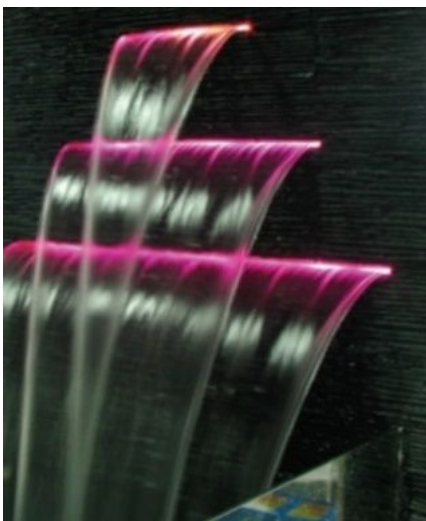

WINTER COVERS

Coperture Invernali

Zimske navlake

SUMMER COVERS

Coperture Estive

Ljetne navlake

AUTOMATIC COVERS

Coperture automatiche

Automatske navlake

POOL EQUIPMENT & SHOWERS

Equipaggiamento per piscine e docce

Bazenska oprema i tuš

WINTER COVERS

Tense and floating Fabrene or Polyethylene winter covers for residential or commercial swimming pools

Our winter covers are made of FABRENE INC. TJJ® which is a technical material studied for this specific purpose. Resistant to frost and to the aggressive action of U.V rays, high tear resistance, tensile strength and elongation. The dark green/black color (opaque) prevents the light from entering thus inhibiting the photosynthesis of algae. The covers are assembled with double-stitching made with synthetic, rot-proof and UV stabilized thread (typically used for marine applications) and finished with the installation of metal eyelets. They can be tense and draining or floating and draining (typical solution for infinity pools) or supplied with a submersible pump for rainwater drainage from the cover. The covers can be projected and tailor-made according to the customer's specific needs and can be equipped with different optionals such as installation and anchoring accessories, water tubes, housing bags etc.

Le nostre coperture invernali sono confezionate in FABRENE INC. TJJ®, materiale tecnico messo a punto e studiato per questo specifico impiego. Insensibile al gelo e resistente a lungo all'azione aggressiva dei raggi U.V, elevatissima resistenza alla lacerazione, trazione ed allungamento. Il colore verde scuro/nero (opaco) impedisce alla luce di filtrare inibendo la fotosintesi clorofilliana delle alghe. Le coperture sono confezionate con doppie cuciture eseguite con filo sintetico imputrescibile e stabilizzato ai raggi U.V. (tipicamente utilizzato per impieghi nautici) e finite con l'istallazione degli occhielli metallici. Possono essere di tipo teso e drenante oppure galleggianti sull'acqua della piscina (soluzione tipicamente scelta per le piscine a sfioro) e drenanti o fornite con una pompa sommersibile dedita allo svuotamento dell'acqua piovana dalla copertura. Le coperture possono essere eseguite a misura a seconda delle necessità ed accessoriate da diversi optional quali ad esempio gli accessori di installazione ed ancoraggio, i tubolari, i sacchi di custodia ecc.

Naše zimske navlake izrađene su od FABRENE INC. TJJ® koji je tehnički materijal proučavan za ovu specifičnu svrhu. Otpornost na mraz i agresivno djelovanje UV zraka, visoka otpornost na trganje, vlačna čvrstoća i istezanje. Tamnozeleno/crna boja (neprozirna) sprječava ulazak svjetlosti čime inhibira fotosintezu algi. Navlake su sastavljene dvostrukim šavovima napravljenim sintetičkim, otpornim na truljenje i UV stabiliziranim koncem (obično se koristi za pomorske primjene) i završene ugradnjom metalnih ušica. Mogu biti napeti i drenažni ili plutajući i drenirajući (tipično rješenje za infinity bazene) ili opremljeni potopnom pumpom za odvodnju kišnice s pokrivala. Pokrivala se mogu projektirati i izraditi po mjeri prema specifičnim potrebama kupca i mogu se opremiti različitim opcijama kao što su pribor za ugradnju i sidrenje, cijevi za vodu, vreće za kućište itd.

CARATERISTICHE / FEATURES / ZNAČAJKE	WINCOGRILL	WINCOVER
		
Peso / Weight / Težina	156g/m2 680gr/m2	156gr/m2
Materiale / Material / Materijal	FABRENE INC. TJJ® - TREVIRA	FABRENE INC. TJJ®
Colori / Colors / Boje	Verde e Nero / Green & Black / Zelena i Crna (Bordo/Edge/Rub: Verde e Bianco / Green & White / Zelena i bijela)	Verde e Nero / Green & Black / Zelena i Crna
Resistenza alla trazione / Traction resistance / Vlačni otpor	880 Newton / 5cm	880 Newton / 5cm
Garanzia / Warranty / Jamstvo	2 anni * / 2 years / 2 godine	2 anni * / 2 years / 2 godine

* Note: Warranty is against UV ray damage



The covers are always provided with drainage for rainwater and a light-blocking layer of material (patella) to avoid sun's rays infiltration into the pool. Le coperture vengono sempre fornite complete di drenaggio per l'acqua piovana e patella oscurante per evitare infiltrazione dei raggi solari nell'acqua. Pokrivala su uvijek opremljena drenažom za kišnicu i materijalom koji služi za zamračenje kako bi se izbjegla infiltracija sunčevih zraka u vodu.

"WINCOGRILL" WINTER COVER

Wincogrill is a tense and draining winter cover, perfect for skimmer or symmetric regular-shaped swimming pools. Made in FABRENE INC. TJJ® with a perimeter reinforcement (in contact with the edge stones) made in PVC and TREVIRA, 425mm wide. It includes a draining line at the centre of the cover, made of a very resistant rot-proof, anti-UV filtering fabric, a bag for summer replacement and steel eyelets (1 every 60cm). The type and quantity of elastics and anchor elements depend on the cover Kit typology: 1 elastic and 1 picket/retreatable anchor every eyelet or every 2 eyelets. Other optionals can be ordered separately. Special cuttings, reinforcements, holes and other specific changes can be made on request.



The cover must be dimensioned considering the swimming pool's internal measures (the water surface) and adding at least 42,5cm on each side; the finished dimensions of the cover should be: pool internal length + 85cm x pool internal width + 85cm. 2 years warranty. Green color with green edge.

Wincogrill è una copertura invernale di tipo drenante e tesa ideale per piscine a skimmer e di forme regolari o simmetriche. Confezionata in FABRENE INC. TJJ® e con fascia perimetrale (a contatto con il bordo) in PVC calandrato, armato di tessuto Trevira, larghezza 425mm. Include una striscia drenante centrale in tessuto filtrante imputrescibile ad elevata resistenza alla lacerazione allo stiramento ed anti UV. Include gli occhielli metallici su tutto il perimetro a distanza di 60 cm tra loro e la sacca di custodia per la rimessa estiva della copertura. La tipologia e le quantità di elastici di tensionamento ed elementi di ancoraggio dipendono dalla tipologia di Kit copertura ordinato e potranno essere 1 elastico ed un ancoraggio (picchetto o piolo a scomparsa) ogni occhiello oppure ogni due occhielli. Altri optional potranno essere ordinati separatamente. Ritagli speciali, rinforzi, occhielli e molte altre specifiche lavorazioni potranno essere effettuate su richiesta. La copertura deve debordare da tutti i lati rispetto lo specchio d'acqua di almeno 42,5cm pertanto le dimensioni finite della copertura saranno sempre almeno: lunghezza specchio acqua + 85 cm x larghezza specchio acqua + 85 cm. Garanzia: 2 anni. Colore verde con bordo verde.

Wincogrill je drenažno zimsko pokrivalo na natezanje idealno za bazene sa skimmerom ili pravilnog i simetričnog oblika. Napravljena od materijala FABRENE INC. TJJ, s pojačanim rubnim dijelom od kalandriranog PVC-a i armiranog s trevira tkaninom - širina ruba 425mm. Uključena je centralna drenažna traka od filtrirajuće tkanine otporne na U.V. zračenje, truljenje, poderotine i na vlačni otpor. Uključuje zaštitnu vreću za ljetno razdoblje i metalne okice po cijelom opsegu s razmakom od 60 cm između svake. Tip i količina gumenih traka za natezanje pokrivala i ostala oprema za učvršćivanje, ovise o vrsti kompleta koji ste naručili: može biti 1 gumena traka/1 klin (ili ispusni sidreni vijak) na svaku očicu ili na svaku drugu očicu. Ostala dodatna oprema se može posebno naručiti. Posebno izrezivanje, pojačanja, otvori i mnoge druge radove pružamo na upit. Pokrivalo mora biti dimenzionirano s obzirom na unutarnje mjere bazena (vodena površina) i dodati najmanje 42,5cm sa svake strane; gotove dimenzije navlake trebaju biti: unutarnja dužina bazena + 85 cm x unutarnja širina bazena + 85 cm. 2 godine jamstva. Zelena boja sa zelenim rubom.

CALCULATION OF THE COVER'S AREA:

Max. length + 85cm x Max. width + 85cm

Lunghezza maggiore + 85cm x Larghezza maggiore + 85cm

Maksimalna dužina + 85cm x Maksimalna širina + 85cm

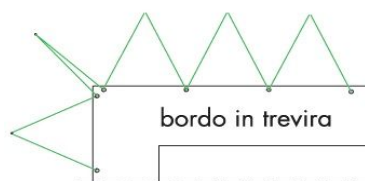

OPTIONAL "DOUBLE" ANCHORS TYPE
1 elastic + 1 anchor every eyelet

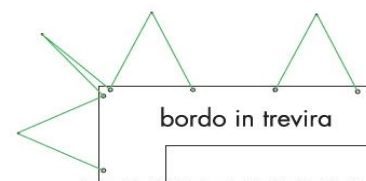

STANDARD ANCHORS TYPE 1 elastic + 1 anchor every 2 eyelets always included!



WINCOGRILL COVER ORDER INSTRUCTION / ISTRUZIONI PER L'ACQUISTO DELLA COP. WINCOGRILL / UPUTE ZA NARUČIVANJE WINCOGRILL POKRIVALA
<p>1) Calculate the surface of the cover in square meters by adding 42,5cm to all sides with respect to the internal surface of the pool - example: 8,0m x 4,0m pool = 8,85m x 4,85m cover = 42,92m²</p> <p>1) Calcolare la superficie della copertura da realizzare in metri quadrati aggiungendo 42,5cm a tutti i lati rispetto la superficie interna della piscina - esempio piscina 8,0m x 4,0m = Copertura 8,85m x 4,85m = 42,92m²</p> <p>1) Izračunajte površinu pokrivala u kvadratnim metrima dodavanjem 42,5 cm na sve strane s obzirom na unutarnju površinu bazena - na primjer 8,0 m x 4,0 m bazen = 8,85 m x 4,85 m pokrivača = 42,92 m²</p>
<p>2) Choose the type of cover according to its shape (rectangular or free form)</p> <p>2) Scegliere la tipologia della copertura in funzione alla sua forma (rettangolare o forma libera)</p> <p>2) Odaberite vrstu pokrivala prema njegovom obliku (pravokutni ili slobodni oblik)</p>
<p>3) Multiply the unit price per square meter by the surface of the cover according to the following method: Price A x square meters up to 25m²; price B x square meters from 25m² on. Example Rectangular coverage: 42.92m² = (11.07 Euro x 25m²) + (8.49 Euro x 17.92m²) = (276.75 +152.14) = 428.49 EUR</p> <p>3) Moltiplicare il prezzo unitario a metro quadrato per la superficie della copertura secondo il seguente metodo: Prezzo A x metri quadrati fino a 25m²; prezzo B per metri quadrati oltre a 25m². Esempio Copertura rettangolare: 42,92m² = (11,07 Euro x 25m²) + (8,49 Euro x 17,92m²) = (276,75 +152,14) =428,49 Euro</p> <p>3) Pomnožite jediničnu cijenu četvornog metra s površinom pokrivala na slijedeći način: Cijena A x četvorni metri do 25m²; cijena B x četvorni metri nakon 25m². Primjer Pravokutnog pokrivala: 42,92m² = (11,07 eura x 25m²) + (8,49 eura x 17,92m²) = (276,75 +152,14) = 428,49 EUR</p>
<p>4) Add any options such as cuts, additional eyelets, reinforcements, double anchors etc.</p> <p>4) Aggiungere eventuali opzionali come ritagli, occhielli supplementari, rinforzi, doppio ancoraggio ecc.</p> <p>4) Dodajte sve opcije kao što su izrezi, dodatne okice, pojačanja, pojačano sidrenje pokrivala itd.</p>

WINCOGRILL COVER



WINCOGRILL COVER INCLUDES:

Central linear drain with anti UV "patella" underneath
 Trevira Perimetral reinforcement at every side of the cover
 Steel eyelets - 1 every 60cm on the entire perimeter
 Cover Bag for summer cover replacement
 "Utility Clip" elastics 70cm long
 At choice between: Stainless steel "P" picket or retractable stainless steel anchor

WINCOGRILL COVER KIT - RECTANGULAR FORM

EN-340101A	WincoGrill cover KIT for rectangular form pools - up to 25m ² Kit Copertura WincoGrill per Piscine a forma rettangolare - fino a 25m ² Komplet WincoGrill pokrivalo za bazene pravokutnog oblika - do 25m ²	M2	Prices on request
EN-340101B	WincoGrill cover KIT for rectangular form pools - more than 25m ² Kit Copertura WincoGrill per Piscine a forma rettangolare - oltre 25m ² Komplet WincoGrill pokrivalo za bazene pravokutnog oblika - preko 25m ²	M2	Prices on request

WINCOGRILL COVER KIT - FREE FORM

EN-340102A	WincoGrill cover KIT for free form pools - up to 25m ² Kit Copertura WincoGrill tipo per Piscine a forma libera - fino a 25m ² Komplet WincoGrill pokrivalo za bazene slobodnog oblika- do 25m ²	M2	Prices on request
EN-340102B	WincoGrill cover KIT for free form pools - more than 25m ² Kit Copertura WincoGrill tipo per Piscine a forma libera - oltre 25m ² Komplet WincoGrill pokrivalo za bazene slobodnog oblika - preko 25m ²	M2	Prices on request

"WINCOVER" WINTER COVER

Floating winter covers "Wincover" are made of FABRENE TJJ fabric. Light and easy to install, suggested for irregular shapes, for infinity or very large swimming pools, suitable to cover obstacles. The cover is supplied with drain in the center, reinforcement on the entire perimeter, eyelets in the corners and a cover bag for the summer replacement. Depending on the model, the cover must be completed with tubes on the entire perimeter, elastics and anchors or both solutions for higher resistance (suggested in very windy areas). In case you choose a Wincover without central drainage, the perimeter edge will be welded rather than sewn to the body of the cover in order to make it perfectly waterproof. The cover must be larger than the swimming pool internal measures; at least 75cm must be added on every side. The finished dimensions of the cover should be: pool water's length + 150cm x pool water's width + 150cm. 2 years warranty. Colors green or black.

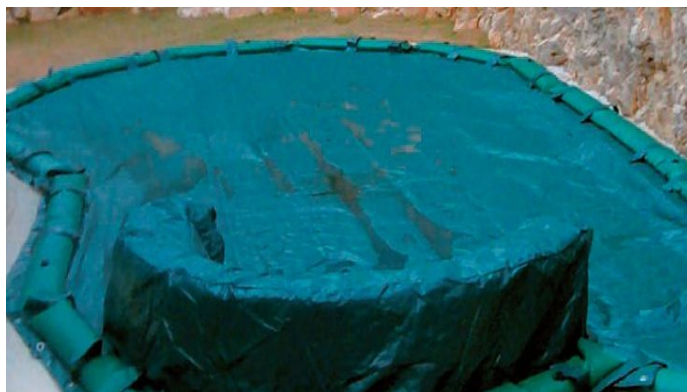

Copertura invernale galleggiante in FABRENE TJJ, leggera e maneggevole da installare e facile da stendere. Consigliata per le forme irregolari, le piscine a sfioro, le piscine con ostacoli o di grandi dimensioni. La copertura è fornita completa di sistema di drenaggio centrale, rinforzo perimetrale su tutti i lati, occhielli metallici negli angoli e sacco di custodia per la rimessa estiva della copertura. Per il completamento della copertura, dipendentemente da modello scelto si possono integrare tubolari ad acqua da inserire nelle tasche perimetrali, elastici ed ancoraggi oppure entrambe le soluzioni assieme (suggerito in condizione di forte vento). Per acquisti di Wincover senza drenaggio centrale, il bordo perimetrale verrà saldato anziché cucito al corpo della copertura così da renderla perfettamente impermeabile. La copertura deve debordare da tutti i lati rispetto lo specchio d'acqua di almeno 75cm pertanto le dimensioni finite della copertura saranno sempre almeno: lunghezza specchio acqua + 150 cm x larghezza specchio acqua + 150 cm. Garanzia: 2 anni. Colore verde o nero.

Zimsko plutajuće pokrivalo od materijala FABRENE TJJ lagano je i jednostavno za instalaciju, lako prilagodljivo i lagano za rastegnuti. Preporučujemo ga za nepravilne oblike, za prelivene bazene, bazene sa preprekama ili bazene velikih dimenzija. Pokrivalo je dostavljeno sa drenažnim sistemom na sredini, pojačanjem po cijelom opsegu, metalnim okicama u kutovima i sa zaštitnom vrećom za ljetno razdoblje. Pokrivala imaju vodene tuljke koji se stavljaju po cijelom opsegu bazena a po želji se mogu dodati i gumene trake i klinovi (ili obje solucije, vodeni utezi i klinovi sa elastičnim trakama, posebice u slučaju jakog vjetra). Kod kupnje Wincovera bez središnje drenaže, rub će bit zavaren a ne prišiven na pokrivalo, kako bi bio savršeno vodootporan. Pokrivalo mora biti najmanje 75 cm šire s obzirom na vodenu površinu sa svih strana, pa bi dimenzije pokrivala trebale uvijek biti barem: dužina vodene površine + 150cm x širina vodene površine + 150cm. Jamstvo 2 godine. Zelena ili crna boja.

CALCULATION OF THE COVER'S AREA:

Max. length + 150cm x Max. width + 150cm

Larghezza maggiore + 150cm x Larghezza maggiore + 150cm

Dužina vodene površine + 150cm x širina vodene površine + 150cm

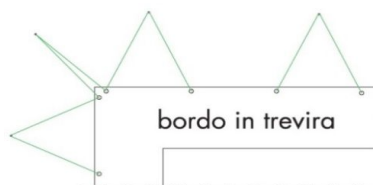

OPTIONAL "DOUBLE" ANCHORS TYPE
1 elastic + 1 anchor every 1 eyelet



1 elastic + 1 anchor every 2 eyelets always included

WINCOVER COVER ORDER INSTRUCTION / ISTRUZIONI PER L'ACQUISTO DELLA COP. WINCOVER / UPUTE ZA NARUČIVANJE WINCOVER POKRIVALA
<p>1) Calculate the area of the cover in square meters by adding 75cm to all sides with respect to the internal surface of the pool - example: 8.0m x 4.0m pool = 9.50m x 5.50m, cover = 52.25m²</p> <p>1) Calcolare la superficie della copertura da realizzare in metri quadrati aggiungendo 75cm a tutti i lati rispetto la superficie interna della piscina - esempio piscina 8,0m x 4,0m = Copertura 9,50m x 5,50m = 52,25m²</p> <p>1) Izračunajte površinu pokrivala u kvadratnim metrima dodavanjem 75 cm na sve strane s obzirom na unutarnju površinu bazena - na primjer: bazen 8,0 m x 4,0 m = 9,50 m x 5,50 m, pokrivalo = 52,25 m²</p>
<p>2) Choose the cover anchoring system between: Type "A" with water tubes, Type "B" with eyelets, Type "C" with both</p> <p>2) Scegliere il sistema di ancoraggio della copertura tra: Tipo "A" con tubolari, Tipo "B" con occhielli, Tipo "C" con entrambi</p> <p>2) Odaberite sustav sidrenja pokrivala između: tipa "A" s vodenim utezima, tipa "B" s okicama, tipa "C" s okicama i vodenim utezima</p>
<p>3) Choose the type of cover according to its shape (rectangular or free form)</p> <p>3) Scegliere la tipologia della copertura in funzione alla sua forma (rettangolare o forma libera)</p> <p>3) Odaberite vrstu pokrivala prema obliku (pravokutni ili slobodni oblik)</p>
<p>4) Multiply the unit price per square meter by the surface of the cover according to the following method: Price A x square meters up to 25m²; price B x square meters more than 25m². Example Cover Type A rectangular: 52.25m² = (10.28 Euro x 25) + (7.11 Euro x 27.25) = (257.00 + 193.75) = 450.75 Euro</p> <p>4) Moltiplicare il prezzo unitario a metro quadrato per la superficie della copertura secondo il seguente metodo: Prezzo A x metri quadrati fino a 25m²; prezzo B x metri quadrati oltre a 25m². Esempio Copertura Type A rettangolare: 52,25m² = (10,28 Euro x 25) + (7,11 Euro x 27,25) = (257,00 + 193,75) = 450,75 Euro</p> <p>4) Pomnožite jediničnu cijenu četvornog metra s površinom pokrivala na slijedeći način: Cijena A x četvorni metri do 25m²; cijena B x četvorni metri nakon 25m². Primjer pravokutnog pokrivala tipa A: 52,25m² = (10,28 eura x 25) + (7,11 eura x 27,25) = (257,00 + 193,75) = 450,75 eura</p>
<p>5) Add any options such as cuts, additional eyelets, reinforcements, etc.</p> <p>5) Aggiungere eventuali opzionali come ritagli, occhielli supplementari, rinforzi, ecc.</p> <p>5) Dodajte sve opcije poput izreza, dodatnih okica, pojačanja itd.</p>

WINCOVER COVER TYPE "A"



WINCOVER KIT TYPE "A" INCLUDES:

Drain net with anti UV "patella" layer at the center of the cover
 Perimetral reinforcement at every side of the cover
 Steel eyelets at the corners of the cover
 Cover Bag for summer cover replacement

Water tubes 600g weight various lengths all around the cover perimeter

WINCOVER COVER KIT TYPE "A" - RECTANGULAR FORM

EN-340201A	Wincover cover KIT for rectangular form pools type "A" - up to 25m ² Kit Copertura Wincover tipo "A" per Piscine a forma rettangolare - fino a 25m ² Komplet Wincover pokrivala za bazene pravokutnog oblika, tip "A" - do 25 m ²	M2	Prices on request
EN-340201B	Wincover cover KIT for rectangular form pools type "A" - more than 25m ² Kit Copertura Wincover tipo "A" per Piscine a forma rettangolare - oltre 25m ² Komplet Wincover pokrivalo za bazene pravokutnog oblika - tip "A" - preko 25m ²	M2	Prices on request

WINCOVER COVER KIT TYPE "A" - FREE FORM

EN-340202A	Wincover cover KIT for free form pools type "A" - up to 25m ² Kit Copertura Wincover tipo "A" per Piscine a forma libera - fino a 25m ² Komplet Wincover pokrivalo za bazene slobodnog oblika, tip "A" - do 25 m ²	M2	Prices on request
EN-340202B	Wincover cover KIT for free form pools type "A" - more than 25m ² Kit Copertura Wincover tipo "A" per Piscine a forma libera - oltre 25m ² Komplet Wincover pokrivalo za bazene slobodnog oblika, tip "A" - preko 25m ²	M2	Prices on request

WINCOVER COVER TYPE "B"



WINCOVER KIT TYPE "B" INCLUDES:

- Drain net with anti UV "patella" layer in center of the cover
- Perimetral reinforcement at every side of the cover
- Steel eyelets - 1 every 60cm on the entire perimeter
- Cover Bag for summer cover replacement
- "Utility Clip" elastics 70cm long - 1 every 2eyelets
- Stainless steel "P" picket or retractable stainless steel anchor

WINCOVER COVER KIT TYPE "B" - RECTANGULAR FORM

EN-340203A	Wincover cover KIT for rectangular form pools type "B" - up to 25m2 Kit Copertura Wincover tipo "B" per Piscine a forma rettangolare - fino a 25m2 Komplet Wincover pokrivalo za bazene pravokutnog oblika, tip "B" - do 25m2	M2	Prices on request
EN-340203B	Wincover cover KIT for rectangular form pools type "B" - more than 25m2 Kit Copertura Wincover tipo "B" per Piscine a forma rettangolare - oltre 25m2 Komplet Wincover pokrivalo za bazene pravokutnog oblikam, tip "B" - preko 25m2	M2	Prices on request

WINCOVER COVER KIT TYPE "B" - FREE FORM

EN-340204A	Wincover cover KIT for free form pools type "B" - up to 25m2 Kit Copertura Wincover tipo "B" per Piscine a forma libera - fino a 25m2 Komplet Wincover pokrivalo za bazene slobodnog oblika, tip "B" - do 25m2	M2	Prices on request
EN-340204B	Wincover cover KIT for free form pools type "B" - more than 25m2 Kit Copertura Wincover tipo "B" per Piscine a forma libera - oltre 25m2 Komplet Wincover pokrivalo za bazene slobodnog oblika, tip "B" - preko 25m2	M2	Prices on request

Note : Please specify in your order the desired fixing system, stainless steel "P" picket or retractable stainless steel anchor

Nota : Specificare nell'ordine il sistema di fissaggio desiderato, picchetto a "P" in acciaio inox o piolo in acciaio inox a scomparsa

Napomena : Navedite u svojoj narudžbi željeni sustav pričvršćivanja, inox "P" klin ili inox podni ispusni sidreni vijak

WINCOVER COVER TYPE "C"



WINCOVER KIT TYPE "C" INCLUDES:

- Drain net with anti UV "patella" layer in center of the cover
- Perimetral reinforcement at every side of the cover
- Steel eyelets - 1 every 60cm on the entire perimeter
- Cover Bag for summer cover replacement
- Water tubes 600g weight/various lenghts all around the cover perimeter
- "Utility Clip" elastics 70cm long - 1 every 2eyelets
- Stainless steel "P" picket or retractable stainless steel anchor



WINCOVER COVER KIT TYPE "C" - RECTANGULAR FORM

EN-340205A	Wincover cover KIT for rectangular form pools type "C" - up to 25m2 Kit Copertura Wincover tipo "C" per Piscine a forma rettangolare - fino a 25m2 Komplet Wincover pokrivalo za bazene pravokutnog oblika, tip "C" - do 25m2	M2	Prices on request
EN-340205B	Wincover cover KIT for rectangular form pools type "C" - more than 25m2 Kit Copertura Wincover tipo "C" per Piscine a forma rettangolare - oltre 25m2 Komplet Wincover pokrivalo za bazene pravokutnog oblika, tip "C" - preko 25m2	M2	Prices on request

WINCOVER COVER KIT TYPE "C" - FREE FORM

EN-340206A	Wincover cover KIT for free form pools type "C" - up to 25m2 Kit Copertura Wincover tipo "C" per Piscine a forma libera - fino a 25m2 Komplet Wincover pokrivalo za bazene slobodnog oblika, tip "C" - do 25m2	M2	Prices on request
EN-340206B	Wincover cover KIT for free form pools type "C" - more than 25m2 Kit Copertura Wincover tipo "C" per Piscine a forma libera - oltre 25m2 Komplet Wincover pokrivalo za bazene slobodnog oblika, tip "C" - preko 25m2	M2	Prices on request

Note : Please specify in your order the desired fixing system, stainless steel "P" picket or retractable stainless steel anchor

Nota : Specificare nell'ordine il sistema di fissaggio desiderato, picchetto a "P" in acciaio inox o piolo in acciaio inox a scomparsa

Napomena : Navedite u svojoj narudžbi željeni sustav pričvršćivanja, inox "P" klin ili inox podni ispusni sidreni vijak

WINTER COVER OPTIONAL

PL-CWRR	Cut of roman stair, steel ladder, fall, inverted angle reinforcement etc. Ritaglio pendice, scala romana, scaletta, cascata o rinforzo per angoli inversi Rubni izrezak, rimske stepenice, ljestve, vodopad ili pojačanje za kutove	N.	Prices on request
PL-CWRT	Trevira reinforcement 50cm x 50cm - application under internal pool or stair angles Rinforzo in trevira 50cm x 50cm - Applicazione sotto angoli interni o lati scale romane Trevira pojačanje 50cmx50cm-montaža ispod unutr. uglova ili kod rimskih stepenica	N.	Prices on request
PL-CIRO	Additional steel eyelets Occhielli metallici supplementari Dodatne metalne okice	N.	Prices on request
PL-CWGB100	Perimeter Trevira reinforcement 100 cm Bordatura perimetrale rinforzata in Trevira da 100cm Pojačani Trevira rub od 100 cm	MT	Prices on request
PL-CWGB75	Perimeter Trevira reinforcement 75 cm Bordatura perimetrale rinforzata in Trevira da 75cm Pojačani Trevira rub od 75 cm	MT	Prices on request

Note: Wincover covers are supplied with central drainage to drain rainwater when removing the cover. If you wish to buy a Wincover without central drainage, please indicate the request in order. In this case it is recommended to purchase the pump for rainwater drainage.

Nota: Le coperture Wincover sono fornite con il drenaggio centrale per lo scolo dell'acqua piovana in fase di rimozione del telo. Per acquistare Wincover senza drenaggio centrale indicare la richiesta in ordine. Si consiglia in questo caso di acquistare la pompa per il drenaggio

Napomena: Pokrivala Wincover isporučuju se s centralnom drenažom za odvod kišnice tijekom uklanjanja istog. Da biste kupili Wincover bez centralne drenaže, molimo vas da to navedete u narudžbi. U tom se slučaju preporučuje kupnja pumpe za odvodnju kišnice.

WINTER COVER ACCESSORIES - ELASTICS



1



2



3

PL-CWTE	1	70cm elastic with "Utiliti Clip" junction piece Elastico 70cm con terminale "Utiliti clip" Gumena traka 70cm s plastičnim kopčama " Utiliti clip"	N.	Prices on request
SC-JOU-700-0013	2	60cm beige elastic with technopolymer junction piece Elastico 60cm beige con terminali in plastica Bež gumena traka 60 cm s plastičnim kopčama	N.	Prices on request
PL-CCE	3	Elastic green color rope for cover fixing Corda elastica verde per fissaggio coperture Zeleno elastično uže za učvršćivanje pokrivaloa	MT	Prices on request

WINTER COVER ACCESSORIES - ANCHORS



1



2



3



4

5



6



7

PL-CPS#14	1	Stainless steel D.6mm "P" picket, 12cm long, for in-floor installation Picchetto a "P" in acciaio inox D.6mm lunghezza 12cm per solaio Inox Klin "P" dužine 12cm, promjer 6mm za podne instalacije	N.	Prices on request
PL-CWPP	2	Polyethylene 30cm picket for in-grass anchoring Picchetto in Polietilene da 30cm per ancoraggio su prato Klin od Polietilena od 30 cm za travnjak	N.	Prices on request
SC-BES-701-0002	3	Stainless steel 29cm "P" picket for in-grass installation Picchetto a "P" in acciaio inox lunghezza 29cm per prato Inox klin "P" dužine 29cm, za travanjak	N.	Prices on request
PL-CPS#25	4	Retractable stainless steel - aluminium anchor 10mm head Piolo a scomparsa acciaio inox ed alluminio testa d. 10mm Inox i aluminijski podni sidreni vijak, glava 10mm	N.	Prices on request
PL-CWPS	6	Retractable brass anchor round head Piolo a scomparsa a vite in ottone testa bombata Podni ispusni sidreni inox vijak, sa širokom glavom	N.	Prices on request
PL-CWPSBA	7	Retractable stainless steel anchor 13mm head Piolo a scomparsa acciaio inox testa d. 13mm Podni ispusni sidreni inox vijak, 13mm glava	N.	Prices on request

WINTER COVER ACCESSORIES - TUBES



1



2

PL-CWT125VE	1	<p>Armed PVC tubes 600g. 125x25cm - Green color</p> <p>Tubolare in PVC armato 600g. 125x25cm - Verde</p> <p>Vodeni uteg od armiranog PVC-a 600g. 125X25cm – Zeleni</p>	N.	Prices on request
PL-CWT200VE	1	<p>Armed PVC tubes 600g. 200x25cm - Green color</p> <p>Tubolare in PVC armato 600g. 200x25cm - Verde</p> <p>Vodeni uteg od armiranog PVC-a 600g. 200X25cm – Zeleni</p>	N.	Prices on request
PL-CWT250VE	1	<p>Armed PVC tubes 600g. 250x25cm - Green color</p> <p>Tubolare in PVC armato 600g. 250x25cm - Verde</p> <p>Vodeni uteg od armiranog PVC-a 600g. 250X25cm – Zeleni</p>	N.	Prices on request
PL-CWT300VE	1	<p>Armed PVC tubes 600g. 300x25cm - Green color</p> <p>Tubolare in PVC armato 600g. 300x25cm - Verde</p> <p>Vodeni uteg od armiranog PVC-a 600g. 300X25cm – Zeleni</p>	N.	Prices on request
PL-CLW05	2	<p>Clip for water tubes installation for already existing covers</p> <p>Clip di tenuta tubolare per installazione su copertura invernale esistente</p> <p>Kopča za ugradnju vodenih utega na već postojeći zimski pokrivalo</p>	N.	Prices on request

Available on request: armed water-tubes of 600m blue color - Dimensions: 125cm; 200cm; 250cm; 300cm

Disponibile su richiesta: Tubi in PVC armato di 600m colore blu - Dimensioni: 125cm; 200 cm; 250 cm; 300 cm

Dostupno na zahtjev: armirani vodeni uteg plave boje od 600m - Dimenzije: 125cm; 200cm; 250cm; 300cm

WINTER COVER ACCESSORIES - OTHER



1



2

PL-CWSC	1	<p>Summer storage green color cover bag</p> <p>Sacco di custodia e rimessaggio estivo copertura Colore verde in PE</p> <p>Zaštitna vreća za ljetno skladištenje pokrivaloa, zelena boja</p>	N.	Prices on request
PL-60115704	2	<p>"Eurocover" IP68 mono-phase submersible pump for cover - 10m cable</p> <p>Elettropompa sommersibile "Eurocover" IP68 monofase 10m cavo</p> <p>Podvodna jednofazna elektro-crpk "Eurocover" IP68 za pokrivala</p>	N.	Prices on request

Note: The order of an Eurocover pump together with a "Wincover" Winter cover Kit leads to an extra discount on the list price as compensation for the replacement of the central drain system included in the cover kit

Nota: in caso di ordine della pompa Eurocover contestualmente al Kit copertura invernale "Wincover" verrà conteggiato un extra sconto sul prezzo di listino quale compensazione per la sostituzione del drenaggio centrale incluso nel kit copertura

Napomena: ako naručite crpku Eurocover istovremeno s Kit-om zimskog pokrivaloa "Wincover", dati ćemo vam dodatni popust na cjenik zbog zamjene središnjeg drenažnog sistema koji je uključen u Kit za pokrivalo.

IMPORTANT NOTE:

Important note: Cover orders will be processed only after written confirmation of IGP's offer and executive drawing by customers

Nota importante: Gli ordini delle coperture verranno processati solamente contro conferma scritta dell'offerta IGP e del disegno esecutivo da parte del cliente

Važna napomena: Narudžbe pokrića bit će obrađene samo nakon pismene potvrde IGP-ove ponude i izvršnog crteža od strane kupaca



SUMMER COVERS

Bubble and Isotherm summer covers for residential or commercial swimming pools

Our summer covers are available in two types: the "BUBBLE" covers are born with the purpose of facilitating the entrance of solar rays in the water through the bubbles that increase the water's temperature during the early hours of the morning. Contextually the temperature is not dispersed thanks to the isothermal properties of the cover, which reduces up to 98% of the evaporation and therefore the dissipation of water heat. The "ISOROLL" isothermal covers are made with more layers of isothermal anti-UV mousse (plastic material) that almost totally prevents heat dissipation. This is the ideal solution for swimming pools heated by heat pumps or heat exchangers and are used even in wellness center SPAs with water at very high temperatures.

Le nostre coperture estive sono disponibili in due tipologie: Le coperture a "bolle" nascono con lo scopo di favorire l'ingresso nell'acqua dei raggi solari tramite le bolle così da permetterne il riscaldamento durante le prime ore del mattino. Contestualmente la temperatura non si disperde grazie alle proprietà isotermitiche della copertura che riduce sino al 98% l'evaporazione e quindi la dissipazione del calore dell'acqua. Le coperture isotermitiche "Isoroll" invece sono dei teli costituiti da più strati di materiale plastico isotermitico a Mousse anti-UV che impediscono quasi totalmente la dissipazione del calore. Sono queste la soluzione ideale per piscine riscaldate da pompe di calore o scambiatori e sono molto utilizzate anche per le SPA nei centri Wellness con acqua a temperature altissime.

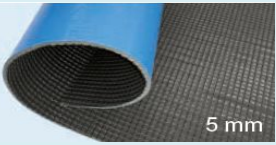
Naša ljetna pokrivala (termo pokrivala) su dostupna u dvije verzije: Solarna pokrivala sa mjehurićima, napravljena s ciljem da omogućie ulazak sunčevih zraka u vodu kroz mjehure koji onda ugriju vodu u prvim jutarnjim satima. Temperatura vode se ne gubi zahvaljujući izotermičkim svojstvima pokrivala koje smanjuju do 98% isparavanja i tako se sprječava smanjenje topline vode. Izotermička pokrivala "Isoroll" su platna napravljena od više slojeva izotermičkog plastičnog materijala Mousse anti-UV, koji skoro potpuno onemogućava toplinsko rasipanje. Idealna su solucija za bazene koji se griju toplinskim pumpama ili izmjenjivačima i obično su korištena i za SPA u Wellness centrima koji drže vodu na iznimno visokim temperaturama.

	ISOROLL LIGHT	ISOROLL STANDARD	ISOROLL DELUXE
CARATERISTICHE / FEATURES / ZNAČAJKE ISOTHERMAL COVERS	 5 mm	 6 mm	 6,5 mm
Spessore / Thickness / Debljina	5mm	6mm	6,5mm
Peso Unitario / Unit weight / Jedinična težina	450 g/mq	532 g/mq	800 g/mq
Tessuto / Fabric / Materijal	Polyethylene	Polyethylene	Polyethylene
Colori / Colors / Boje	Azzurro-Grigio / Light Blue-Grey / Svjetlo plava-Siva	Azzurro / Light Blue / Svjetlo plava	Azzurro / Light Blue / Svjetlo plava
Garanzia / Warranty / Jamstvo	2 anni / 2 years / 2 godine	2 anni / 2 years / 2 godine	2 anni / 2 years / 2 godine

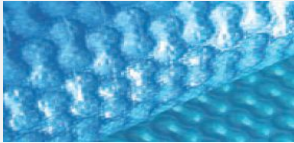
	SUNGLO	SUNGUARD DELUXE	SUNWEAVE
CARATERISTICHE / FEATURES / ZNAČAJKE BUBBLES COVERS			
Spessore / Thickness / Debljina	400 μ	500 μ	600 μ
Peso Unitario / Unit weight / Jedinična težina	368 g/mq	460 g/mq	540 g/mq
Tessuto / Fabric / Materijal	Polyethylene	Double Polyethylene	Double Polyethylene
Colori / Colors / Boje	Azzurro / Azure / Svjetlo plava	Azzurro trasparente / Transparent Azure / Prozirno-svjetlo plava	Bluette / Bluette / Svjetlo plava
Garanzia / Warranty / Jamstvo	2 anni / 2 years / 2 godine	5 anni / 5 years / 5 godine	2 anni / 2 years / 2 godine

BUBBLES SUMMER COVERS

Bubble summer floating covers made in anti-UV thermoplastic and polyethylene material of different thickness and weight depending on the model, to be chosen between Sunglo, Sunguard Delux and Sunweave (See the summer cover table). If ordered together with the roll, they include fitting band (standard length of 80 cm) and tow rope. The transparency of the cover allows the leaking of the infrared rays that increase water temperature and reduce the evaporation up to 98%, consequently reducing heating and maintenance costs, plus the costs of energy, water and chemical products. To order and calculate the measures of the cover, remove 1cm from every swimming pool side.



Coperture estive galleggianti a bolle realizzate con materiale termoplastico e polietilene anti-UV di vario spessore e peso a seconda del modello scelto tra Sunglo, Sunguard Delux e Sunweave (Vedi tabella coperture estive). Se ordinata assieme al rullo avvolgitore sono comprese le bande di raccordo lunghezza standard 80 cm e la corda da traino. La trasparenza consente l'attraversamento dei raggi infrarossi che aumentano la temperatura dell'acqua in piscina. La coperture riduce fino al 98% l'evaporazione e di conseguenza i costi di riscaldamento e di mantenimento con la riduzione dell'utilizzo di energia, di acqua e conseguentemente di prodotti chimici. All'ordine, togliere 1cm di scarto per ogni lato rispetto la misura della superficie d'acqua.

Solarna plutajuća ljetna pokrivala (Termo pokrivala) s mjehurićima izrađena su od termoplastičnog i polietilenskog materijala anti-UV raznih debljina i težina ovisno o željenom modelu između Sunglo, Sunguard Delux i Sunwave (pogledaj tabelu ljetna pokrivala). Ako se naruči sa namatalicom uključene su i montažne trake standard dužine 80cm i vučno užje. Prozirnost dopušta ulazak infracrvenih zraka koje povećavaju temperaturu bazenske vode. Pokrivalo smanjuje do 98% isparavanja, smanjujući tako trošak grijanja i održavanja vode i automatski smanjuje potrošnju energije, vode i kemijskih sredstava. Kad naručujete pokrivalo trebate skinuti 1cm dužine sa svake strane (širina i dužina vodene površine).

SUMMER COVER ORDER INSTRUCTION / ISTRUZIONI PER L'ACQUISTO DELLA COPERTURA ESTIVA / UPUTE ZA NARUČIVANJE LJETNIH POKRIV.
1) Choose the the summer cover typology and multiply its price for the square meters of the water surface / Scegli la tipologia della copertura e moltiplica il suo prezzo con i metri quadrati della superficie dell'acqua / Odaberi tip ljetnog pokrivaloa i pomnoži njezinu cijenu sa vodenom površinom (m2)
2) Add the optional cut for stair/obstacle (if needed) / Aggiungi l'opzione taglio scala romana/altro ostacolo (se necessario) / Dodaj opciju Izrez za rimske stepenice / ili druge prepreke (ako je potrebno)
3) Add the roller system (if needed) / Aggiungi un sistema di avvolgimento (se necessario) / Dodaj sistem za namatanje (po želji)
4) Add other optionals as eyelets, fitting band, reinforcement, etc; / Aggiungi altri accessori come occhielli, bande di raccordo, rinforzi, ecc. / Dodaj ostale dodatke kao npr. okice, trake za spajanje na roller, pojačanja itd.

NOTE : if you buy the FLOATING BAR you have to add 16 cm to the long side of the cover: E.g. $4,00*(8,00+ 0,16) = 32,64m^2$

ATTENZIONE : se acquisti la BARRA GALLEGGIANTE aggiungere 16 cm alla lunghezza della copertura. Es.: $4,00*(8,00+ 0,16) = 32,64m^2$

POZOR: ako želiš kupiti PLUTAJUĆU ŠIPKU dodaj 16 cm na dugu stranu pokrivaloa. Npr.: $4,00*(8,00+ 0,16) = 32,64m^2$

BUBBLE SUMMER COVERS - SUNGLO

PL-CSA	"Sunglo" bubble cover - Rectangular swimming pools Copertura solare a bolle "Sunglo" - Piscine rettangolari Solarni pokrivalo "Sunglo" - Pravokutni bazeni	M2	Prices on request
PL-CSAFS	"Sunglo" bubble cover - Irregular form swimming pools Copertura solare a bolle "Sunglo" - Piscine non rettangolari Solarni pokrivalo "Sunglo" - Bazeni nepravilnog oblika	M2	Prices on request

BUBBLES SUMMER COVERS - SUNWEAVE

PL-COP#016112	"Sunweave" bubble cover - Rectangular swimming pools Copertura solare a bolle "Sunweave" - Piscine rettangolari Solarni pokrivalo "Sunweave" - Pravokutni bazeni	M2	Prices on request
PL-COP#016113	"Sunweave" bubble cover - Irregularly shaped swimming pools Copertura solare a bolle "Sunweave" - Piscine non rettangolari Solarni pokrivalo "Sunweave" - Bazeni nepravilnog oblika	M2	Prices on request

BUBBLE SUMMER COVERS - SUNGUARD DELUXE

PL-CSGA	"Sunguard Delux" bubble cover - Rectangular swimming pools Copertura solare a bolle "Sunguard Deluxe" - Piscine rettangolari Solarni pokrivalo "Sunguard Delux" - Pravokutni bazeni	M2	Prices on request
PL-CSGAFS	"Sunguard Delux" bubble cover - Irregularly shaped swimming pools Copertura solare a bolle "Sunguard Deluxe" - Piscine non rettangolari Solarni pokrivalo "Sunguard Delux" - Bazeni nepravilnog oblika	M2	Prices on request

ISOROLL ISOTHERM SUMMER COVERS

Isotherm floating summer covers made of anti-UV thermoplastic and polyethylene mousse materials of different thickness and weight depending on the model, to be chosen between Isoroll light, standard e deluxe (See the summer cover table). If ordered together with the roll, they include fitting bands (standard 80 cm long) and the tow rope. The top layer of the cover is an anti UV rip resistant PE. The intermediate layer is an isotherm PE mousse. The low layer is very resistant to chemicals and microorganisms. The isotherm cover keeps the swimming pool's water temperature almost totally stable. To order and calculate the measures of the cover, remove 1cm from every swimming pool side.



Coperture estive galleggianti isotermitiche realizzate con materiale termoplastico a mousse anti-UV di vario spessore e peso a seconda del modello scelto tra Isoroll light, standard e deluxe (v. tabella coperture estive). Se ordinata assieme al rullo avvolgitore sono comprese le bande di raccordo lunghezza standard 80cm e la corda di traino. Lo strato superiore di rinforzo è una lamina in PE armato anti UV ad elevata resistenza allo strappo. Lo strato intermedio è una mousse isolante in PE. La membrana inferiore in PE svolge la funzione di resistenza ai prodotti chimici ed allo sviluppo di microrganismi. La copertura isotermitica mantiene quasi totalmente la temperatura dell'acqua sottostante. All'ordine, togliere 1cm di scarto per ogni lato rispetto la misura della superficie d'acqua.

Ljetna izotermitička plutajuća pokrivala napravljena od termoplastičnog spužvastog anti-UV materijala razne debljine i težine, ovisno o željenom modelu između Isoroll light, standard i deluxe (pogledaj tabelu ljetna pokrivala). Ako se naruči s namatačem, uključene su i montažne trake standard dužine 80cm i vučno uže. Gornji sloj je lamina od armiranog anti UV PE materijala s visokom otpornošću na poderotine. Srednji sloj je napravljen od PE materijala s izolirajućem premazom. Sloj u dodiru s vodom je napravljen od PE materijala i ima funkciju otpornosti na kemijska sredstva i na razvoj mikroorganizma. Izotermitičko pokrivalo održava skoro u potpunosti temperaturu vode. Kad naručujete pokrivalo trebete skinuti 1cm dužine sa svake strane (širina i dužina vodene površine).

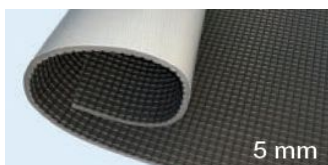

Isoroll Light cover can be ordered in the light grey Platinum version at the same price - upon request

La copertura Isoroll Light può essere ordinata nella versione Platinum grigio allo stesso prezzo - su richiesta

Isoroll Light pokrivalo se može naručiti i u verziji Platinum po istoj cijeni - na zahtjev

SUMMER COVER ORDER INSTRUCTION / ISTRUZIONI PER L'ORDINE DELLA COPERTURA ESTIVA / UPUTE ZA NARUČIVANJE LIETNIH POKRIV.

- 1) Choose the the summer cover typology and multiply its price for the square meters of the water surface / Scegli la tipologia della copertura e moltiplica il suo prezzo per i metri quadrati della superficie dell'acqua / Odaberi tip ljetnog pokrivaloa i pomnoži njezinu cijenu sa vodenom površinom (m2)
- 2) Add the optional cut for stair/obstacle (if needed) / Aggiungi l'opzione taglio scala romana/altro ostacolo (se necessario) / Dodaj opciju Izrez za rimske stepenice / ili druge prepreke (ako je potrebno)
- 3) Add the roller system (if needed) / Aggiungi un sistema di avvolgimento (se necessario) / Dodaj sistem za namatanje (po želji)
- 4) Add other optionals as eyelets, fitting band, reinforcement, etc; / Aggiungi altri accessori come occhielli, bande di raccordo, rinforzi, ecc. / Dodaj ostale dodatke kao npr. okice, trake za spajanje na roller, pojačanja itd.

NOTE : if you buy the FLOATING BAR you have to add 16 cm to the long side of the cover: E.g. $4,00*(8,00+ 0,16) = 32,64m^2$

ATTENZIONE : se acquisti la BARRA GALEGGIANTE aggiungere 16 cm alla lunghezza della copertura. Es.: $4,00*(8,00+ 0,16) = 32,64m^2$

POZOR: ako želiš kupiti PLUTAJUĆU ŠIPKU dodaj 16 cm na dugu stranu pokrivaloa. Npr.: $4,00*(8,00+ 0,16) = 32,64m^2$

ISOTHERM SUMMER COVERS - ISOROLL LIGHT

PL-CIR5	"Isoroll light" 5mm thick. Isotherm cover - Rectangular swimming pools Copertura isoteramica "Isoroll light" 5mm - Piscine rettangolari Izotermičko pokrivalo "Isoroll light" 5mm – Pravokutni bazeni	M2	Prices on request
PL-CIR5FS	"Isoroll light" 5mm thick. Isotherm cover - Irregularly shaped swimming pools Copertura isoteramica "Isoroll light" 5mm - Piscine non rettangolari Izotermičko pokrivalo "Isoroll light" 5mm – Bazeni nepravilnog oblika	M2	Prices on request

ISOTHERM SUMMER COVERS - ISOROLL STANDARD

PL-CIR6	"Isoroll standard" 6mm thick. Isotherm cover - Rectangular swimming pools Copertura isoteramica "Isoroll Standard" 6mm - Piscine rettangolari Izotermičko pokrivalo "Isoroll Standard" 6mm – Pravokutni bazeni	M2	Prices on request
PL-CIR6FS	"Isoroll standard" 6mm thick. Isotherm cover - Irregularly shaped swimming pools Copertura isoteramica "Isoroll Standard" 6mm - Piscine non rettangolari Izotermičko pokrivalo "Isoroll Standard" 6mm – Bazeni nepravilnog oblika	M2	Prices on request

ISOTHERM SUMMER COVERS - ISOROLL DELUXE

PL-CIR6D	"Isoroll Deluxe" 6,5mm thick. Isotherm cover - Rectangular swimming pools Copertura isoteramica "Isoroll Deluxe" 6,5mm - Piscine rettangolari Izotermičko pokrivalo "Isoroll Deluxe" 6,5mm – Pravokutni bazeni	M2	Prices on request
PL-CIR6DFS	"Isoroll deluxe" 6,5mm thick. Isotherm cover - Irregularly shaped swimming pools Copertura isoteramica "Isoroll Deluxe" 6,5mm - Piscine non rettangolari Izotermičko pokrivalo "Isoroll Deluxe" 6,5mm – Bazeni nepravilnog oblika	M2	Prices on request

BUBBLES AND ISOTHERM COVERS OPTIONAL

PL-CSESS	Special cover folding production - Per meter Lavorazione per piegatura a soffietto - Al metro Posebna izrada sklopivog pokrivala - Na metar	N.	Prices on request
----------	---	----	-------------------

Special cover folding production for small pools or/and for pools that don't have the possibility of installing a roller

Lavorazione speciale per piscine di piccole dimensioni e/o per strutture che non hanno la possibilità di installare un sistema di avvolgimento

Posebna izrada sklopivog pokrivala za male bazene i/ili za bazena na koje se ne može instalirati namatalicu

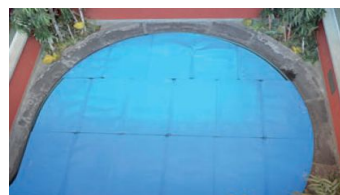
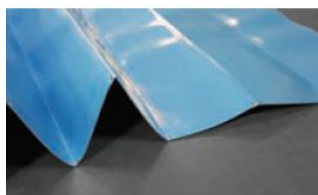

PL-CIRR	Cut of appendice, roman stair, steel ladder, falls or angle rounding Ritaglio pendice, scala romana, scaletta, cascata o arrotondamenti angoli Rubni izrezak, rimske stepenice, vodopad ili pojačanje za suprotne kutove	N.	Prices on request
---------	--	----	-------------------

PL-CIRO	<p>Additional steel eyelets Occhielli metallici supplementari Dodatne metalne okice</p>	N.	Prices on request
PL-CBR	<p>Bands for fixing the cover to the roller (included when you order a roller) Banda di fissaggio al rullo avvolgitore (incluso con rullo quando acquistato) Trake za pričvrščivanje pokrivaloa na namatalicu (uključene kad se naruči namatalica)</p>	N.	Prices on request
PL-CISK	<p>Alluminium roller fixing kit, connecting bands, buttons and screws included Kit di fissaggio al rullo avvolgitore per rullo in alluminio - Bande, bottoni e viti Komplet za pričvrščivanje na namatalicu od aluminija, uključeni su trake, dugmad i vijci</p>	N.	Prices on request
PL-CISKA	<p>Inox roller fixing kit, connecting bands, buttons and screws included Kit di fissaggio al rullo avvolgitore per rullo in acciaio inox - Bande, bottoni e viti Komplet za pričvrščivanje na namatalicu od inoxa, uključeni su trake, dugmad i vijci</p>	N.	Prices on request
PL-KCMOS	<p>Cover moving kit with 13,5m rope and snap hook kit corda 13,5m e moschettone per traino copertura estiva Kit uže 13,5 i karabiner za vuču ljetnog pokrivala</p>	N.	Prices on request
PL-CSB	<p>Edging of the head or perimeter for bubble covers Bordatura delle testate o perimetrale per coperture a bolle Obrubljivanje opsega ili kraće strane bubble pokrivaloa</p>	MT	Prices on request
PL-CSTR	<p>Reflective cloth cover for protection of cover on the roller Telo riflettente per protezione copertura quando avvolta dal rullo largh. 3500 mm Reflektirajuće platno za zaštitu pokrivaloa kada stoji na namatalici</p>	MT	Prices on request
PL-CSBGM4	<p>Floating bar for Isoroll cover up to 4m width Barra galleggiante - per coperture Isoroll fino a 4m di larghezza Plutajuća šipka za pokrivaloe Isoroll do 4m širine</p>	N.	Prices on request
PL-CSBGM8	<p>Floating bar for bubble cover up to 8m width Barra galleggiante - per coperture a bolle fino a 8m di larghezza Plutajuća šipka za bubble pokrivaloe do 8m širine</p>	N.	Prices on request

AUTOMATIC AND MANUAL ROLLER FOR SUMMER COVERS

Automatic and manual roller for summer covers. 5 models: in stainless steel 316, aluminium or pultruso (for salt water pools).

AUTOMATIC ROLLER FOR SUMMER COVERS

AQUACOVER ELEGANT

Automatic winding roller, made of AISI 316. Side supports covered with white shockproof thermoplastic resin casing, UV resistant. Gearmotor unit operating at low voltage 24 V DC, compact, enclosed in an aluminum body (protection IP55). Designed to be fully integrated into the side shoulder of the roller. With simplified electronic control unit with 220/24 V transformer housed in a box for wall installation in reinforced synthetic material, control with key. 24 V direct current power supply. Remote control for remote operation on request. Optional limit switch (on request). Covering with slats: optional. 2 year warranty, excluding electrical components.

Sistemi di avvolgimento automatici, realizzati in AISI 316. Supporti laterali rivestiti con carter in resina termoplastica antiurto colore bianco, resistente agli UV. Gruppo motoriduttore funzionante a bassa tensione 24 V CC, di tipo compatto, racchiuso in un corpo di alluminio (grado protezione IP55). Progettato per essere completamente integrato nella spalla laterale dell'avvolgitore. Completo di centralina elettronica semplificata con trasformatore 220/24 V alloggiata in scatola per installazione a parete in materiale sintetico rinforzato, ad azionamento a chiave. Alimentazione 24 V a corrente continua. Telecomando per azionamento a distanza a richiesta. Predisposizione per fine corsa (a richiesta). Rivestimento opzionale con doghe. Garanzia 2 anni, escluse componenti elettriche.

Valjak za automatsko namatanje, izrađen od AISI 316. Bočni nosači prekriveni bijelim kućištem od termoplastične smole otporno na udarce, UV otporno. Jedinica s reduktorom koja radi na niskonaponskom 24 V DC, kompaktna, zatvorena u aluminijsko kućište (stupanj zaštite IP55). Dizajniran za potpuno integriranje u bočno rame namatalice. U kompletu s pojednostavljenom elektroničkom upravljačkom jedinicom s transformatorom 220/24 V smještenim u kutiji za zidnu ugradnju od ojačanog sintetičkog materijala, upravljanje putem ključa. Napajanje istosmjernom strujom od 24 V. Daljinski upravljač - na zahtjev. Mogućnost ugradnje blokade/zaustavljanja namatanja (na zahtjev). Pokrivanje lamelama (na zahtjev). Dvogodišnje jamstvo, isključujući električne komponente.

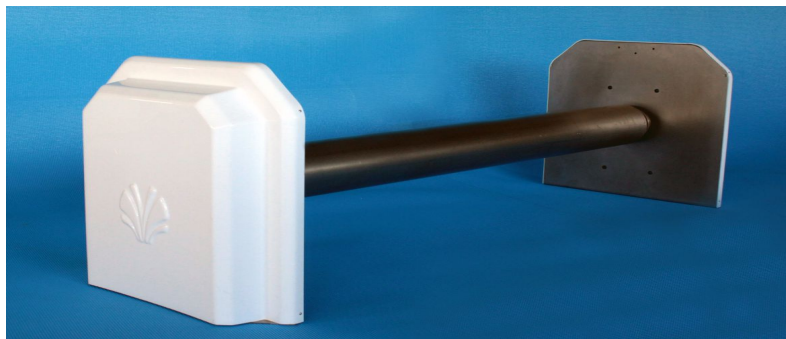

It is possible to supply a manual Aquacover Elegant roller and a complete set for wall installation- on request

Possibilità di fornitura del rullo Aquacover Elegant manuale e/o completo del kit per il fissaggio a parete - su richiesta

Mogućnost dobave ručne namatalice Aquacover Elegant zajedno s priborom za pričvršćivanje na zid - na zahtjev

Optional remote controller



Optional covering / Copertura opzionale del rullo / Obloga namatalice



STEPPE EXCLUSIVE

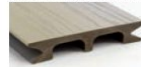

PROVENCE



COLUMBIA



MONTANA



ALGARVE



QUEBEC EXCLUSIVE







ROLLER DESCRIPTION	TYPE	ROLL CODE	MAX POOL WIDTH	ROLL PRICE
Rullo Aquacover Elegant Automatico AISI 316 - 5m larghezza max piscina	STAINLESS STEEL 316	PL-AQCVELEG5	5 MT	On request
Rullo Aquacover Elegant Automatico AISI 316 - 6m larghezza max piscina		PL-AQCVELEG6	6 MT	On request
Rullo Aquacover Elegant Automatico AISI 316 - 7m larghezza max piscina		PL-AQCVELEG7	7 MT	On request
Rullo Aquacover Elegant Automatico AISI 316 - 8m larghezza max piscina		PL-AQCVELEG8	8 MT	On request

MANUAL ROLLER FOR SUMMER COVERS

Aquacover manual roller complete with wheels and pins for floor fixing. Manual crank for opening and closing of the cover. Available in aluminum, stainless steel and pultruded resin for salt water.

Avvolgitori manuali Aquacover completi di ruote e perni per il fissaggio a pavimento. Manovella manuale per l'apertura e chiusura del telo. Disponibili in alluminio, acciaio inox e resina pultrusa per acqua salata.

Aquacover ručne namatalice u kompletu s kotačima i klinovima za pričvršćivanje na podu. Ručna radilica za otvaranje i zatvaranje pokrivala. Dostupno u aluminiju, nehrđajućem čeliku i pultrudiranoj smoli za slanu vodu.

ROLLER DESCRIPTION	TYPE	ROLL CODE	MAX POOL WIDTH	ROLL PRICE
 <p>Senior 160</p> <p>Aquacover Senior 160: per piscine fino a 160mq. Altezza all'asse 41,5 cm, Larghezza rullo 49 cm, incluse ruote.</p> <p>Aquacover Senior 160: for swimming pools up to 160mq. Roll height 41,5 cm, roll diameter 49 cm, wheels included</p> <p>Aquacover Senior 160: za bazene do 160mq. Visina namatalice 41,5cm, širina valjka 49cm, uključeni kotači.</p>	STAINLESS STEEL 316	PL-ACS160A3166M PL-ACS160A3167M PL-ACS160A3168M	6 MT 7 MT 8 MT	On request On request On request
	PULTRUSO	PL-ACS160APUL6M	6 MT	On request
 <p>Senior 140</p> <p>Aquacover Senior 140 adatto a coperture fino a 140mq. Altezza all'asse 35 cm, larghezza rullo 38 cm incluse ruote;</p> <p>Aquacover Senior 140: for swimming pools up to 140mq. Roll height 35 cm, roll diameter 38 cm, wheels included</p> <p>Aquacover Senior 140: za bazene do 140mq. Visina namatalice 35cm, širina valjka 38cm, uključeni kotači.</p>	STAINLESS STEEL 316	PL-ACS140A3165M PL-ACS140A3166M PL-ACS140A3167M	5 MT 6 MT 7 MT	On request On request On request
	PULTRUSO	PL-ACS140APUL5M PL-ACS140APUL6M	5 MT 6 MT	On request On request
 <p>Senior 100</p> <p>Aquacover 100 per piscine fino a 100mq. Altezza all'asse 28 cm. larghezza rullo 38 cm; incluse ruote;</p> <p>Aquacover 100: for swimming pools up to 100mq. Roll height 28cm, roll diameter 38 cm, wheels included</p> <p>Aquacover Senior 100: za bazene do 100mq. Visina namatalice 28cm, širina valjka 38cm, uključeni kotači.</p>	ALUMINIUM	PL-AC100ALU4M PL-AC100ALU5M PL-AC100ALU6M	4 MT 5 MT 6 MT	On request On request On request
	PULTRUSO	PL-AC100PUL4M PL-AC100PUL5M PL-AC100PUL6M	4 MT 5 MT 6 MT	On request On request On request
 <p>Senior 60</p> <p>Aquacover 60 per coperture fino a 60mq. Altezza all'asse 26cm, larghezza rullo 15cm. senza ruote;</p> <p>Aquacover Senior 60: for swimming pools up to 60mq. Roll height 26 cm, roll diameter 15 cm, without wheels.</p> <p>Aquacover Senior 60: za bazene do 60mq. Visina namatalice 26cm, širina valjka 15cm, bez kotača.</p>	ALUMINIUM	PL-AC60ALU4M PL-AC60ALU5M	4 MT 5 MT	On request On request
	PULTRUSO	PL-AC60PUL4M PL-AC60PUL5M	4 MT 5 MT	On request On request

AQUAMATIC AUTOMATIC COVERS

Automatic covers for residential or commercial swimming pools



Isothermal covers "AQUAMATIC" composed of solid shock-proof top quality PVC slats 75 x 13mm (62.5 x 13mm net), stabilized with anti yellowing additives and resistant to ultraviolet and chlorine. Arcuate slat structure with perfectly smooth surface, which ensures a high insulation degree thanks to the air chamber distributed over the entire length. The ends of the slats consist of two elements: a fixed terminal in ABS welded with ultrasound technique (to guarantee total impermeability) and a removable terminal available in three different lengths, plus a version with levilen bristles. Standard colors: ice white, sand, blue sky, caribbean green, magnesium gray. On request available in RAL color codes. Optionally it is possible to choose isothermal slats with a very high thermal insulation degree and each type of customization. All our covers are supplied with stainless steel roller, remote control unit and a special unit panel which is equipped for the installation of weather sensors such as anti-hail, wind gauge and water level and many other features.

Coperture isoterliche "AQUAMATIC" costituite da doghe in solido PVC antiurto di prima qualità e sezione 75 x 13 mm (utile 62,5 x 13 mm), caricato e stabilizzato con additivi anti ingiallimento, resistente agli UV e cloro. Struttura delle doghe arcuate con superficie perfettamente liscia che garantisce un elevato grado di isolamento grazie alla camera d'aria distribuita sull'intera lunghezza. Estremità delle doghe costituite da due elementi: un terminale fisso in ABS saldato con tecnica ad ultrasuoni (a garanzia della totale impermeabilità) e un terminale removibile disponibile in tre lunghezze differenti, più una versione con setole in levilene. Colori standard: bianco ghiaccio, sabbia, azzurro cielo, verde Caraibi, grigio magnesio. A richiesta: colori su codice RAL. In optional è possibile scegliere anche doghe isoterliche ad elevatissimo grado di isolamento termico e personalizzazioni di ogni tipo. Tutte le nostre coperture vengono fornite in versione standard con rullo in acciaio inox, telecomando e centralina pedisposta all'installazione dei sensori climatici quali ad esempio il sensore antigraedine, l'anemometro, il sensore di livello acqua e molti altri.

Izoterička pokrivala "AQUAMATIC" napravljena od čvrstih anti-shock lamela od PVC-a vrhunske kvalitete, 75 x 13 mm (neto 62,5 x 13mm), PVC materijal je stabiliziran s aditivima protiv požucenja, otporan na UV i klor. Savinuta struktura lamela sa savršeno glatkom površinom osigurava visok stupanj izolacije zahvaljujući komori koja se proteže preko cijele duljine. Krajnji dijelovi lamela sastoje se od dva elementa: fiksni terminal od ABS-a zavarenog s ultrazvučnom tehnikom (garancija potpune nepropusnosti) i izmjenjivog priključka dostupnog u tri različite dužine, i jedna verzija s četkicama od levilena. Standardne boje: bijela - boja leda, pijesak, svijetlo plava, karipsko zelena, siva. Po izboru: RAL kodovi boja. Po izboru moguće je odabrati lamele s visokim stupnjem toplinske izolacije i prilagodbe svakog tipa. Sva naša pokrivala se isporučuju u standard verzijama s namatalicom od nehrđajućeg čelika, daljinskim upravljačem i upravljačkom jedinicom koja već ima predispoziciju za ugradnju klimatskih senzora kao što su: senzor protiv tuče, senzor za vjetar, senzor razine vode i mnoge druge.

SEVERAL SOLUTIONS TO PROVIDE AN EXCELLENT COVER TO EVERY SWIMMING POOL

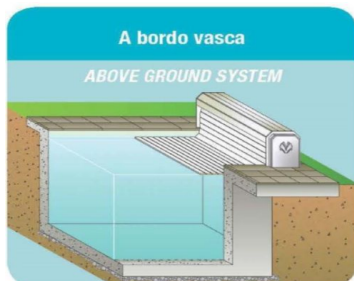
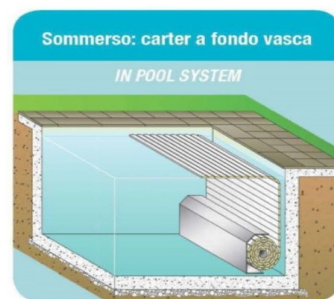

Aquamatic offers two solutions: Above ground (deck-mounted) installation on the pool side: typically used for existing pools. Underwater: for pools under construction

If your pool is already built and you don't want to resort to costly renovations, the Above Ground System is the ideal solution. The reel system, positioned on the pool side, with our elegant casing, reinforced with stainless steel profiles, can be used as a sundeck bench

If your pool is under construction, the ideal thing is to build a pit, behind the pool wall. The Below Ground System is a greatly practical solution, without environmental impact. In any case the whole Aquamatic cover is rolled up below the water level, disappearing from view, without taking up space on the pool

Aquamatic offre due soluzioni: Installazione sopra bordo piscina "Above Ground": Installazione tipica delle piscine esistenti. Installazione subacquea: Per piscine in costruzione

Se la tua piscina è già stata costruita e non vuoi intraprendere costose ristrutturazioni la soluzione "Above Ground" (Soprabordo) è l'ideale. Il sistema finito, posizionato sul lato della piscina, con le nostre eleganti cover rinforzate con profili di acciaio inox può essere utilizzato anche come una panchina

Se la tua piscina è in costruzione, la soluzione ideale è di costruire un vano per la copertura dietro il muro della piscina. Il sistema "Below Ground" è una soluzione pratica e priva di impatto ambientale, il rullo della copertura si muove sotto il livello dell'acqua scomparendo alla vista e senza portare via spazio alla piscina

Acquamatic pruža dvije opcije: prva je montiranje na rub bazena "above ground", tipično montiranje kod već postojećih bazena. Druga je podvodno montiranje: za bazene u izgradnji

Ako je tvoj bazen već izgrađen i ne želiš skupe dodatne radove, najbolja je opcija "Above ground" (na rubu bazena). Gotov sustav na rubu bazena, obložen s našim elegantnim lamelama, s pojačanjem od nehrđajućeg čelika, može se koristiti kao klupica

Ako je tvoj bazen tek u izgradnji, idealno rješenje je izgradnja prostora za pokrivalo iza bazena. Sistem "below ground" je praktično rješenje i nema nikakav vizalni efekt na okoliš. Namatalica s pokrivalom radi ispod razine vode, ne vidi se i ne uzima prostor oko bazena

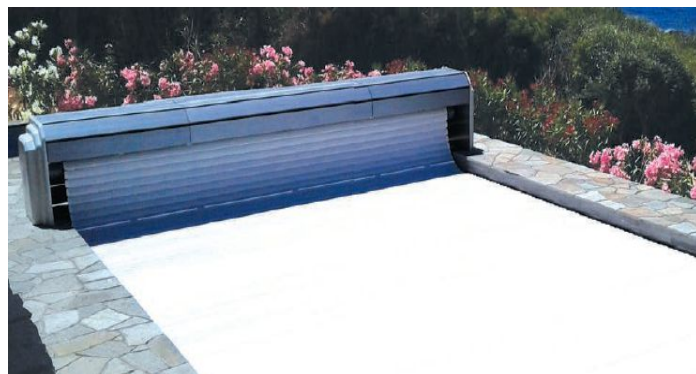

BELOW GROUND INSTALLATION

ABOVE GROUND INSTALLATION

OFFERTA SU RICHIESTA ! - OFFER ON REQUEST ! - PONUDA NA ZAHTJEV!

POOL EQUIPMENT

STAINLESS STEEL LADDERS

Stainless steel 316L ladders for all swimming pools typologies and accessories

STAINLESS STEEL LADDERS "STANDARD" TYPE



Polished stainless steel 316L ladder "Standard". Structure diameter 43mm, non-slip steps. Supplied with anchoring accessories for installation in concrete.

Scaletta in acciaio inox 316L modello "Standard" con Diametro struttura 43 mm e finitura a lucido. Gradini antiscivolo, fornita con ancoraggi di fissaggio per installazione nel cemento.

stepenice od poliranog nehrđajućeg čelika 316L vrste „Standard”. Promjer strukture 43 mm, protuklizne ljestve. Isporučuje se s priborom za sidrenje za ugradnju u beton.

All spare parts available

Stainless steel 316L

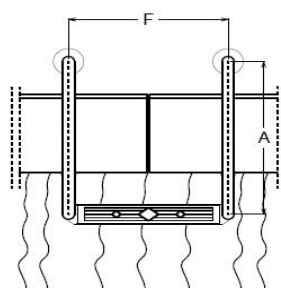
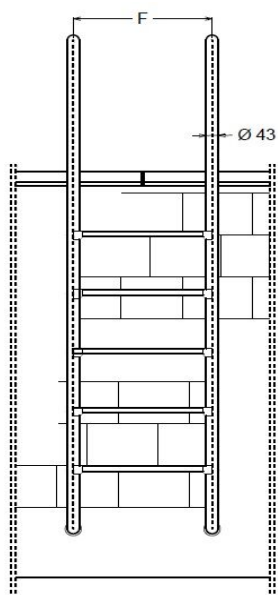
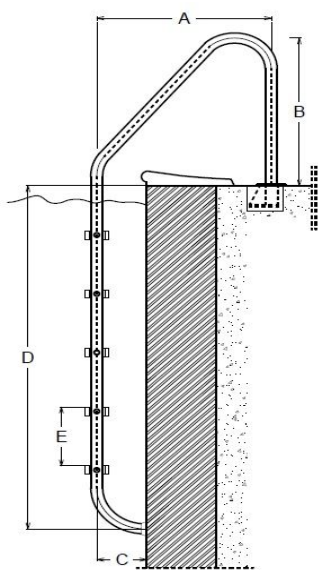

MODELLO STANDARD
STANDARD TYPE

CODICE CODE	TIPO TYPE	A	B	C	D	E	F
		mm	mm	mm	mm	mm	mm
05 302	INOX/2	650	620	180	710	250	500
05 303	INOX/3	650	620	180	960	250	500
05 304	INOX/4	650	620	180	1210	250	500
05 305	INOX/5	650	620	180	1460	250	500

MR-05303A316

Stainless steel 316L 3 steps ladder "Standard"
Scala tipo "Standard" inox 316 a 3 gradini
Inox ljestve 316L s 3 gazišta "Standard"

N.

Prices on request

MR-05304A316

Stainless steel 316L 4 steps ladder "Standard"
Scala tipo "Standard" inox 316 a 4 gradini
Inox ljestve 316L s 4 gazišta "Standard"

N.

Prices on request

MR-05305A316

Stainless steel 316L 5 steps ladder "Standard"
Scala tipo "Standard" inox 316 a 5 gradini
Inox stepenice 316L s 5 gazišta "Standard"

N.

Prices on request

WATERFALLS, WATER BLADES, JETS AND GAMES

ABS and stainless steel waterfalls and jets, water blades and games for residential and commercial pools

ABS WATER DESCENT

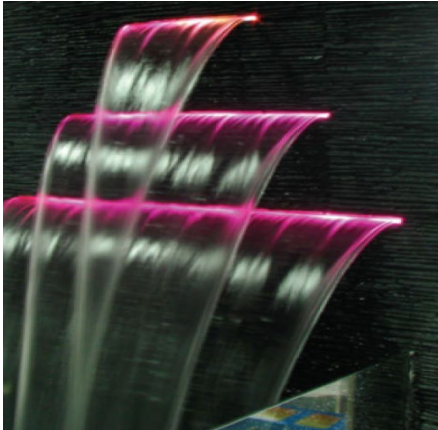

Water Descent ABS units of different dimensions with 50mm 1,5" connection for in-wall installation in newly constructed swimming pools. Available in 4 different widths and optionally with a RGB LED lighting integrated system, which can be managed through control unit and remote controller.

Cascade a lama d'acqua in ABS di diverse dimensioni con connessione 50mm 1,5" per installazione a parete in piscine di nuova realizzazione. Disponibili in 4 larghezze ed in optional con impianto di illuminazione a LED RGB integrato e regolabile da centralina di controllo e telecomando.

ABS vodopad različitih veličina s priključkom 50 1,5" za ugradnju u stijenku novoizgrađenih bazena. Dostupno u 4 različite širine i opcionalno s ugrađenim RGB LED sustavom osvjetljenja kojim je moguće upravljati putem upravljačke jedinice i daljinskog upravljača.

FEATURES:

Built-in waterproof RGB Lighting system (as optional)

Remote control system for LED light included

All descents can be controlled by the same control unit

Made with very resistant ABS material

Corrosion-proof

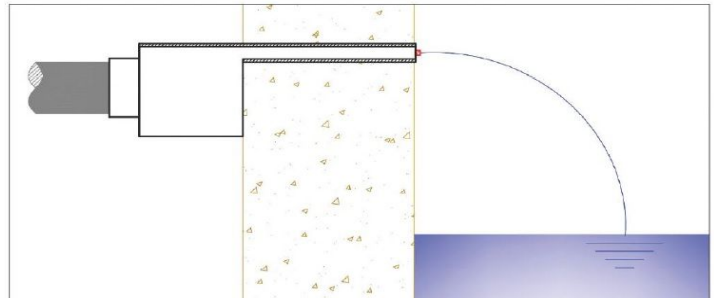

INSTALLATION SCHEME

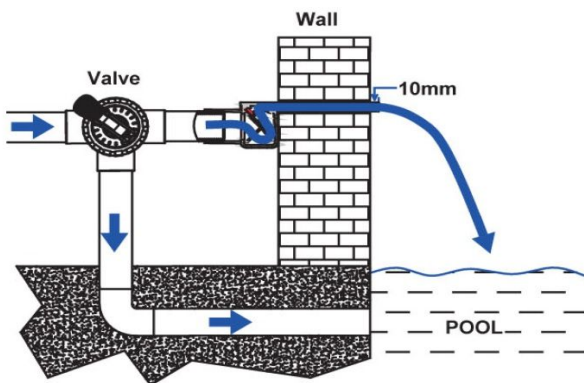

SHEET OF WATER PROJECTION

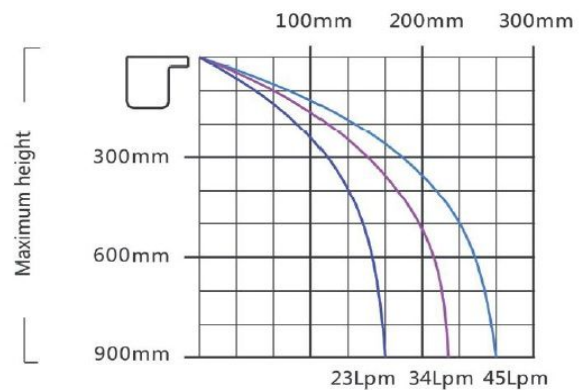

Universal control unit with remote controller for RGB lighting system of water descents. It can be use for all descent models of the same series

Pannello di controllo con telecomando per sistema di illuminazione a LED RGB delle lame d'acqua. Può essere utilizzato per tutti i tipi di lame d'acqua della serie

Univerzalna upravljačka jedinica s daljinskim upravljačima za RGB sustav osvjetljenja vodopada. Moguće je upotrijebiti za sve modele vodopada iste serije



EX-8080035

Unit for the waterdescent RGB lights control

Centralina di controllo sistema illuminazione Lama d'acqua con fari RGB

Upravljačka jedinica za kontrolu RGB svjetla na ABS vodopadima

N.

Prices on request

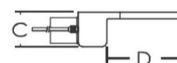
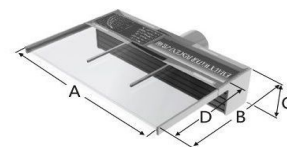
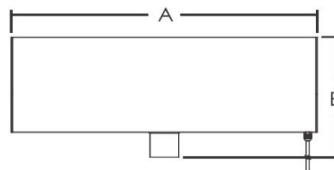
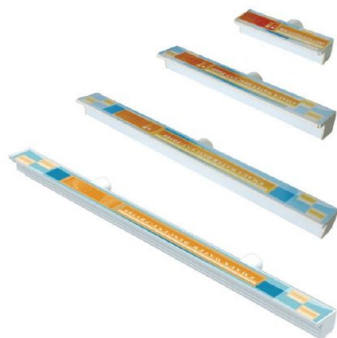

STANDARD ABS WATER DESCENTS

CODE	FLOW RANGE	REMARK	D (mm)	A (mm)	B (mm)	C (mm)	CONNECTION
EX-88485002	1,3 - 2,7 m ³ /h	nd	150	306	263	76	1,5" - 50mm
EX-88485012	2,6 - 5,4 m ³ /h	nd	150	606	263	76	1,5" - 50mm
EX-88485022	4,2 - 8,1 m ³ /h	nd	150	906	263	76	1,5" - 50mm

WATER DESCENTS WITH RGB LIGHTING SYSTEM

CODE	FLOW RANGE	REMARK	D (mm)	A (mm)	B (mm)	C (mm)	CONNECTION
EX-88480102	1,3 - 2,7 m ³ /h	12V DC 4W	150	306	263	76	1,5" - 50mm
EX-88480112	2,6 - 5,4 m ³ /h	12V DC 8W	150	606	263	76	1,5" - 50mm
EX-88480122	4,2 - 8,1 m ³ /h	12V DC 12W	150	906	263	76	1,5" - 50mm

STANDARD ABS WATER DESCENTS

EX-88485002	<p>ABS Water descent 300mm width</p> <p>Lama d'acqua in ABS larghezza 300mm</p> <p>ABS vodopad širine 300 mm</p>	N.	Prices on request
EX-88485012	<p>ABS Water descent 600mm width</p> <p>Lama d'acqua in ABS larghezza 600mm</p> <p>ABS vodopad širine 600 mm</p>	N.	Prices on request
EX-88485022	<p>ABS Water descent 900mm width</p> <p>Lama d'acqua in ABS larghezza 900mm</p> <p>ABS v širine 900 mm</p>	N.	Prices on request

WATER DESCENTS WITH RGB LIGHTING SYSTEM

EX-88480102	<p>ABS Water descent 300mm width with RGB LED lighting</p> <p>Lama d'acqua in ABS con luci LED RGB larghezza 300mm</p> <p>ABS vodopad širine 300 mm s RGB LED osvjetljenjem</p>	N.	Prices on request
EX-88480112	<p>ABS Water descent 600mm width with RGB LED lighting</p> <p>Lama d'acqua in ABS con luci LED RGB larghezza 600mm</p> <p>ABS vodopad širine 600 mm s RGB LED osvjetljenjem</p>	N.	Prices on request
EX-88480122	<p>ABS Water descent 900mm width with RGB LED lighting</p> <p>Lama d'acqua in ABS con luci LED RGB larghezza 900mm</p> <p>ABS vodopad širine 900 mm s RGB LED osvjetljenjem</p>	N.	Prices on request

"COBRA" STAINLESS STEEL WATER FALLS



"Cobra" stainless steel 316 waterfall. Different blade widths available. A specific anchoring element is needed for the cascade to work properly. An aspiration system and a pump are necessary to complete the plant.

Cascata "Cobra" in acciaio inox AISI 316, getto con diversi diametri disponibili. Per il corretto funzionamento della cascata è necessario l'ancoraggio specifico. Per completare l'impianto servono anche un sistema di aspirazione ed una pompa.

Vodopad „Cobra“ od nehrđajućeg čelika 316L. Dostupne različite širine mlaza. Potreban je poseban element za pričvršćivanje kako bi vodopad radio pravilno. Potreban je sustav za aspiraciju i pumpa za kompletiranje rada vodopada.

Stainless steel 316L

CODICE CODE	TIPO TYPE	A	B	C	Ø D	PORTATA FLOW RATE
71 300	CB/300	300	650	600	2" F	20 mc/h
71 500	CB/500	500	650	600	2 1/2" F	32 mc/h
71 650	CB/650	650	800	750	3" F	50 mc/h

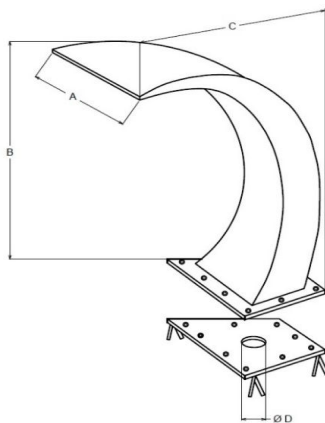
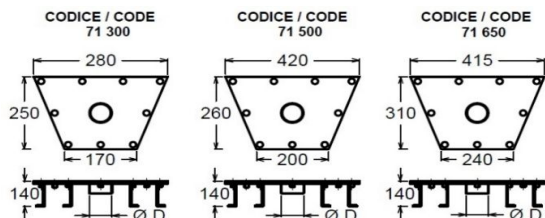

All spare parts available

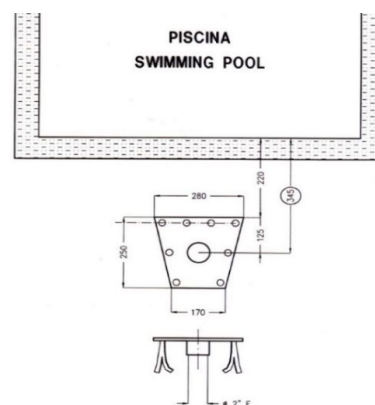

"COBRA" STAINLESS STEEL WATER FALLS

MR-71300	"Cobra" waterfalls 316L stainless steel, 300mm width, 20m ³ /h flow rate Cascata "Cobra" Acciaio inox 316L larghezza 300mm portata 20m ³ /h Vodopadi „Cobra“ od nehrđajućeg čelika 316L, širine 300 mm, protoka 20 m ³ /h	N.	Prices on request
MR-71500	"Cobra" waterfalls 316L stainless steel, 500mm width, 32m ³ /h flow rate Cascata "Cobra" Acciaio inox 316L larghezza 500mm portata 32m ³ /h Vodopadi „Cobra“ od nehrđajućeg čelika 316L, širine 500mm, protoka 32m ³ /h	N.	Prices on request

"COBRA" FIXING COMPONENTS

MR-71300A	"Cobra" waterfalls stainless steel fixing kit for MR-71300 Controflangia acciaio inox 316L per cascata "Cobra" MR-71300 Komplet za fiksiranje vodopada „Cobra“ MR-71300 od nehrđajućeg čelika	N.	Prices on request
MR-71500A	"Cobra" waterfalls stainless steel fixing kit for MR-71500 Controflangia acciaio inox 316L per cascata "Cobra" MR-71500 Komplet za fiksiranje vodopada „Cobra“ MR-71500 od nehrđajućeg čelika	N.	Prices on request

SHOWERS AND ACCESSORIES

Polyethylene, aluminium and stainless steel showers and footwasher for residential and commercial applications

"HAPPY FIVE" SOLAR SHOWER



"Happy Five" Solar polyethylene shower 29L with mixer for temperature regulation (cold/hot) and footwasher. 9 colors available.

Doccia solare in polietilene "Happy Five" con 29l di serbatoio e mixer per la regolazione della temperatura caldo/freddo e lavapiedi. 9 colori disponibili.

Polietilenski solarni tuš „Happy Five“ od 29 l s miješalicom za regulaciju temperature (hladno/toplo) i s dodatnom slavinom za pranje nogu. 9 boja na raspolaganju



AK-880102

Polyethylene Solar shower 28L "Happy Five" with cold/hot mixer and footwasher
 Doccia Solare 28L PE "Happy Five" con mixer caldo/freddo e lavapiedi
 Polietilenski solarni tuš „Happy Five“, 28 lit., hladno/toplo, slavina za pranje nogu

N.

Prices on request

PE & ALUMINIUM SOLAR SHOWER



Available on request !!
 Disponibile su richiesta!!
 Dostupno na zahtjev!!

STAINLESS STEEL SOLAR SHOWERS



Stainless steel solar showers with cold/hot temperature mixer and footwasher of different dimensions and designs included. Showers have no counter-flanges.

Docce solari in acciaio inox 316L con mixer acqua caldo/freddo e lavapiedi di serie incluso. Diverse dimensioni e tipologie disponibili. Le docce sono provviste di controflange.

Solarni tuš od nehrđajućeg čelika s miješalicom temperature hladno/toplo za pranje nogu s uključenim različitim dimenzijama i dizajnima. Tuševi nemaju prirubnice.

All spare parts available

Stainless steel 316L

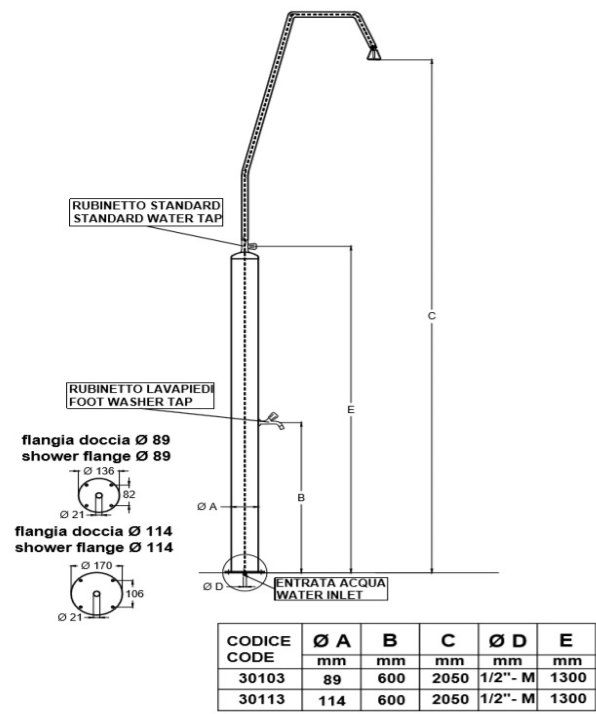
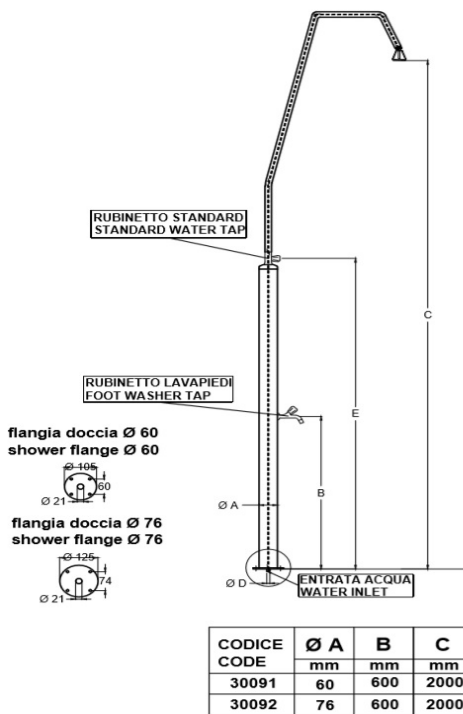

MR-30092

Stainless steel 316L solar shower 5L 76cm with cold/hot button and footwasher
 Doccia Solare Lt 5 D.76cm inox 316L con pulsante caldo/freddo e lavapiedi
 Inox solarni tuš 316L od 5 lit D76 cm s gumbom hladno/toplo i slavinom za pranje nogu

N.

Prices on request

MR-30103

Stainless steel 316L solar shower 6L 89cm with cold/hot button and footwasher
 Doccia Solare Lt 6 D.89cm inox 316L con pulsante caldo/freddo e lavapiedi
 Inox solarni tuš 316L od 6 l D89 cm s gumbom hladno/toplo i slavinom za pranje nogu

N.

Prices on request

MR-30113

Stainless steel 316L solar shower 15L 114cm with cold/hot button and footwasher
 Doccia Solare Lt 15 D.114cm inox 316L con pulsante caldo/freddo e lavapiedi
 Inox solarni tuš 316L od 15l D114 cm s gumbom hladno/toplo i slavinom za pranje nogu

N.

Prices on request